

# User Manual-Smart Keybox

## TTLOCK VERSION

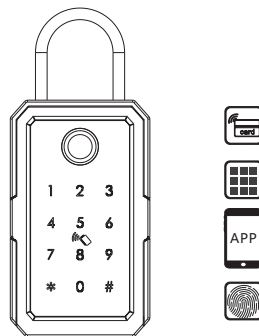

Bring you Smart life!

Version 1.2 Edition K3-TTLOCK

## 1 PACKING ACCESSORIES

Please check the packing box and accessories when you got the item in hand.

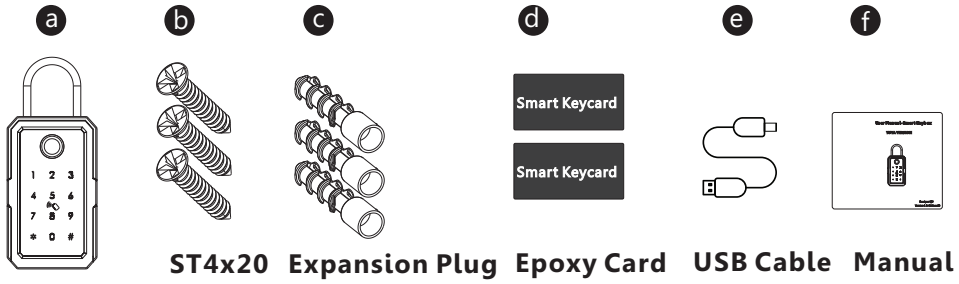

## 2 PRODUCT SPECIFICATION

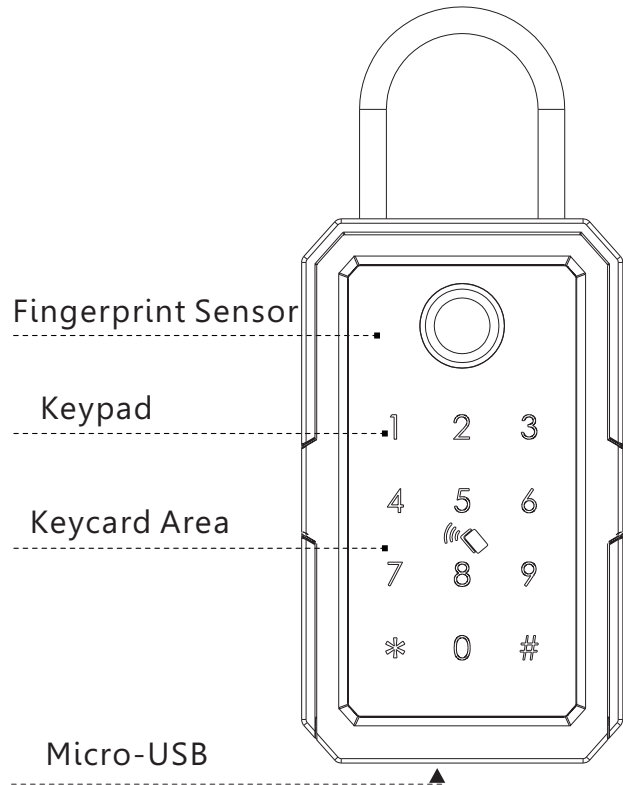

1

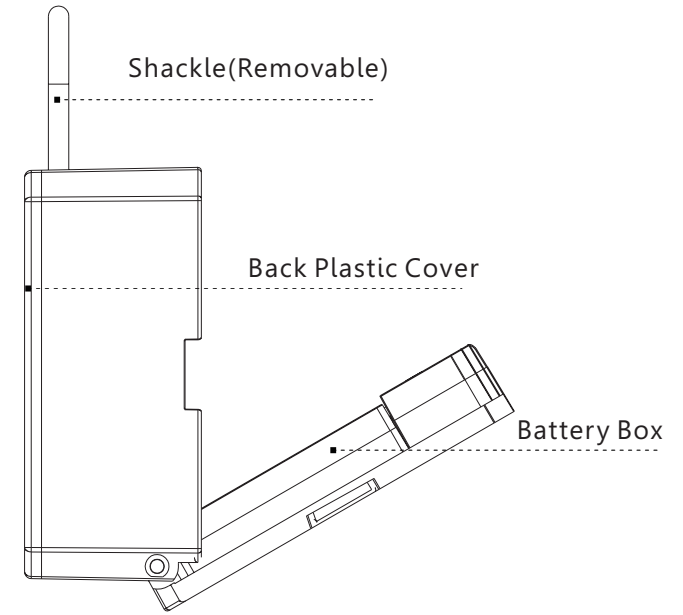

## DIMENSION

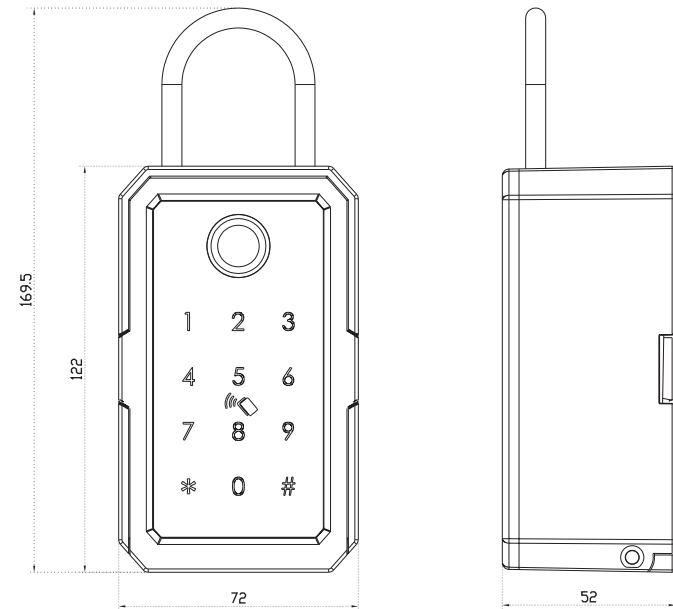

2

### 3 RESET TO FACTORY STATE

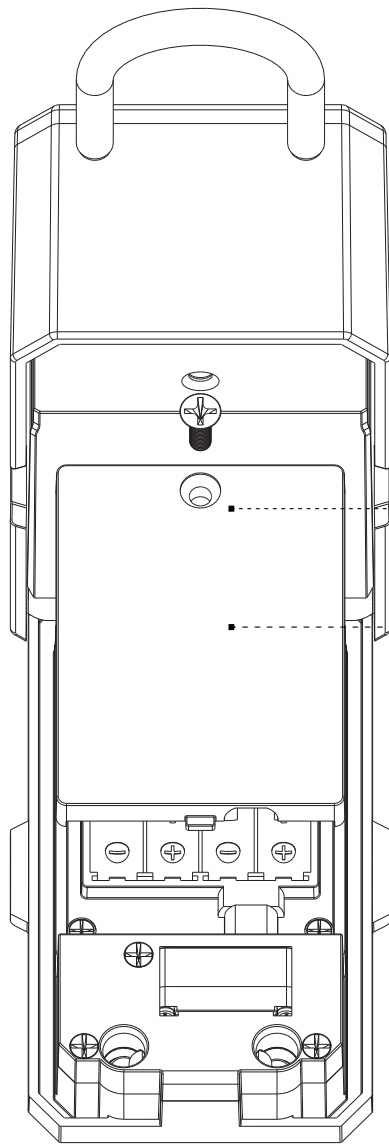

**Open the key box**  
**Take off this screw with**  
**one screwdriver and open**  
**the battery box cover.**



**Battery Box Cover**

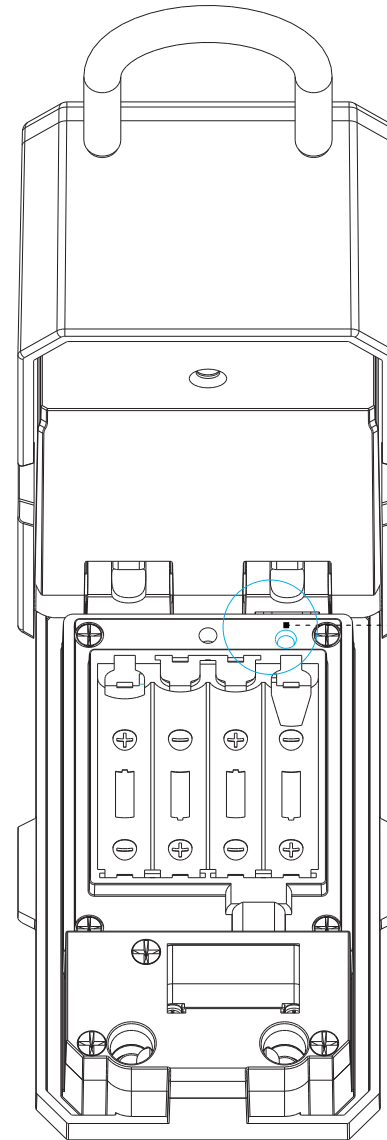

**1. Long press the reset button 2 seconds**  
**2. With sound tip after reset**  
**3. Factory state password: 123456**

**Reset Button**

## 4 INSTALLATION DEMO

According to the usage condition, you can fix the key box on the wall or hang with the cylindrical lock.

### 4.1 INSTALL ON THE WALL

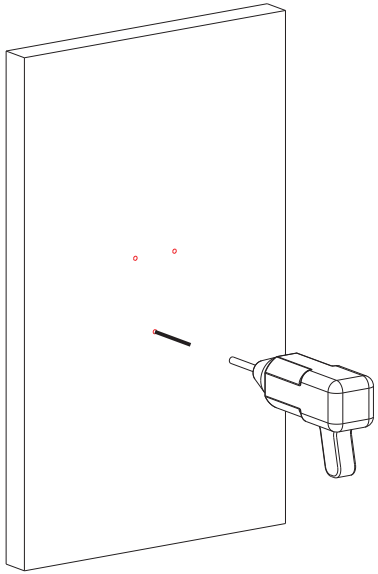

4.1.1 Drill 3 holes with the key box

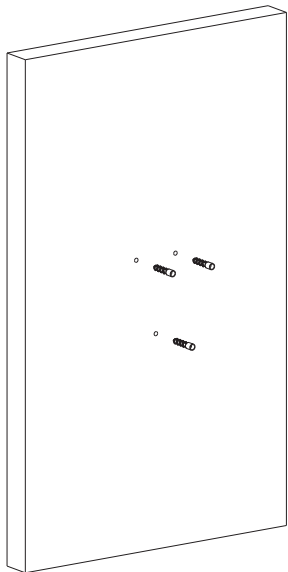

4.1.2 Punch the plastic expansion plug into the hole.

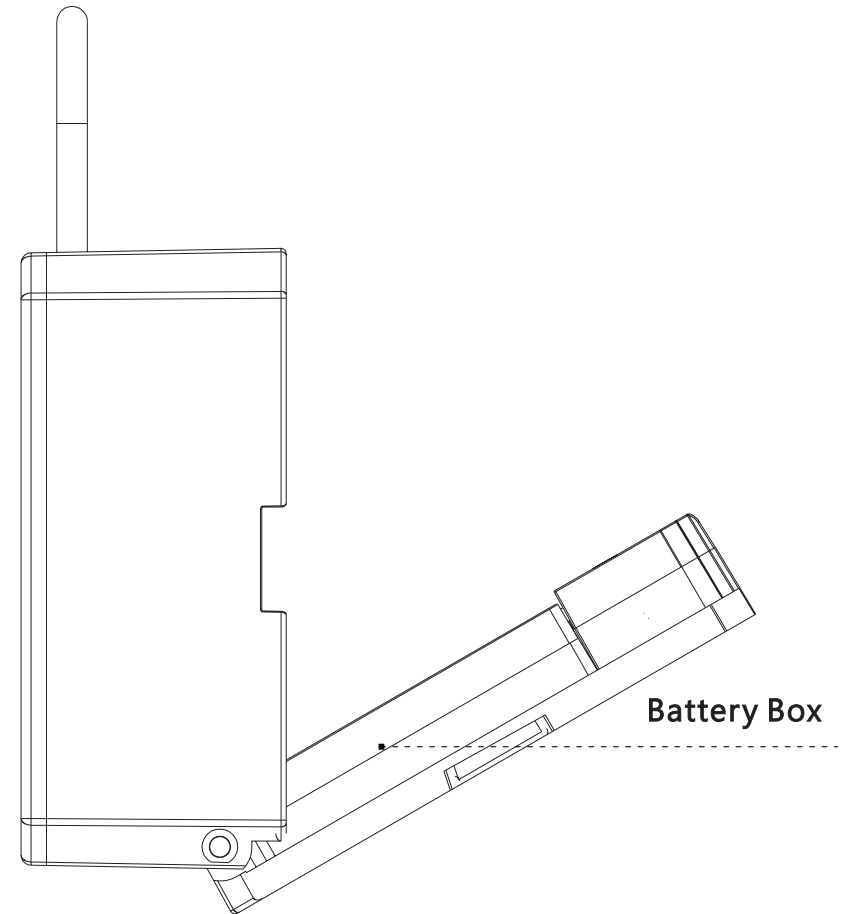

4.1.3 Fix the key box with the screws, test the lock with 4pcs AAA batteries.

## 4.2 HUNG WITH THE CYLINDRICAL LOCK

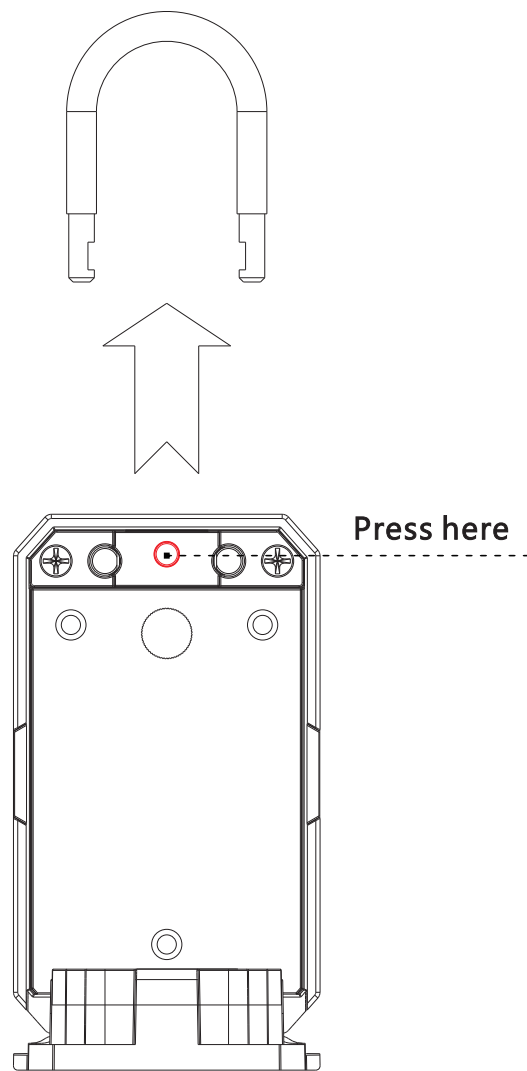

4.2.1 Press the button inside the box as above, take off the shackle.

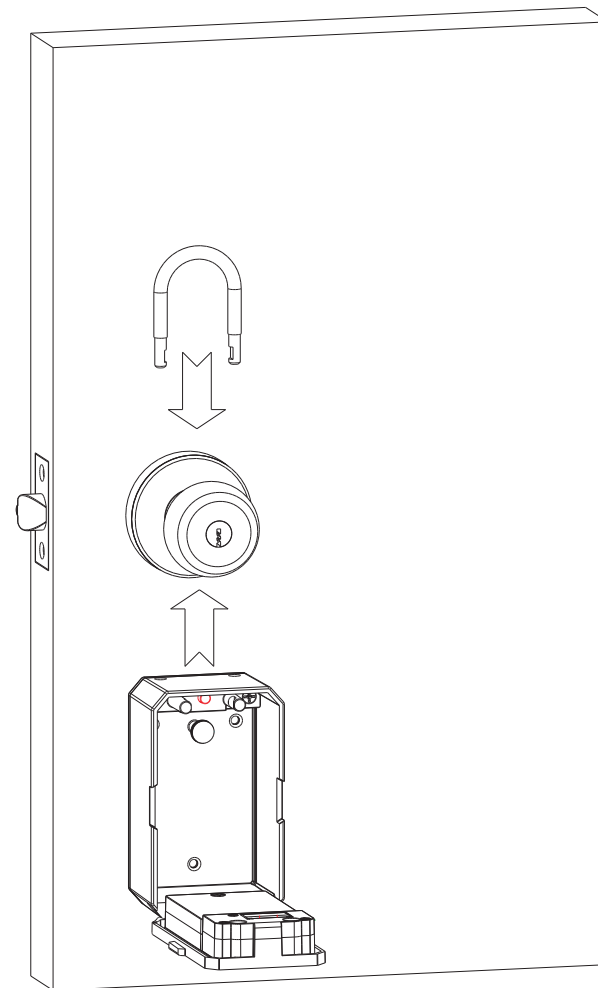

4.2.2 Insert the shackle into the hole on the keybox above, fasten with the cylindrical lock.

## TTLOCK APP OPERATION STEPS

Search Google play or APPLE Store with TTLOCK to download the APP. Install it or scan the below QR code we provided to install the APP program. You can also turn to us to download the application. please read the manual carefully before installation and keep it properly.



- Please turn on your phone's Bluetooth function before any operation.

### ⚠ Attention

## 1.Add one smart lock on your phone

- When adding the door lock, operations must be completed near the lock and the keypad is activated during paring.

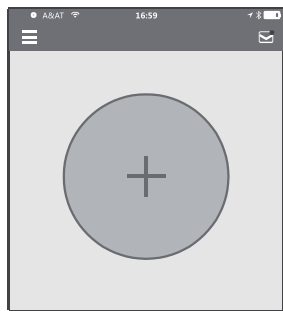
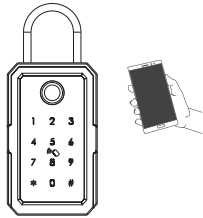

Step1: Click "+" button

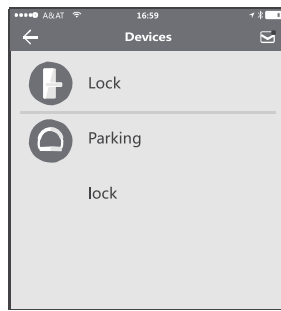

Step2: Select the lock

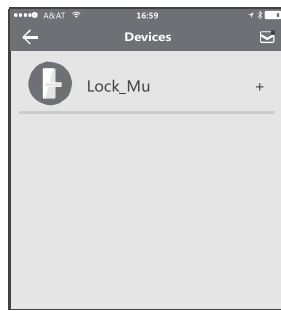

Step3: Click device name

- In step 3: there will be on "+" button after the name of the door lock, notice the door lock can not be added if there is no "+" sign. The interface will jump back to the key list after adding successfully.
- If the operation is failed, please repeat the above steps and view the device list in steps 3. Make sure your mobile is turned on with bluetooth feature and door lock is powered with the battery already.

## 2.Send one permanent eKey

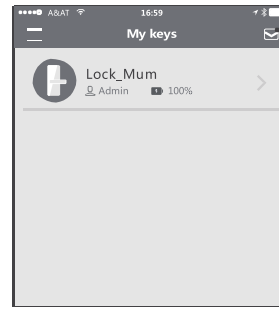

Step1: Click device name

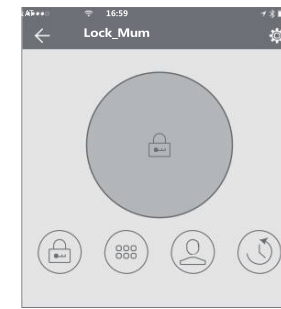

Step2: Click the eKey

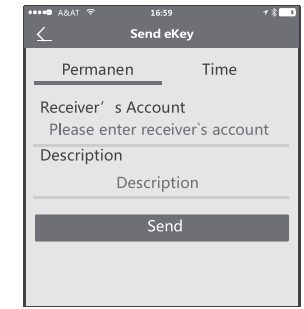

Step3: Enter the receiver info

## 3. Send one timed eKey

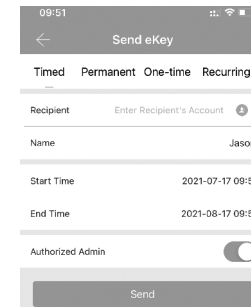

- During the authorized period of time, the receiver can unlock the door without times limit, after the limitation of time, it will be invalidated automatically

## 4. Send a timed passcode

- Passcode is with four types: permanent, timed, cyclic and one-time, you can set the passcode accordingly and share to the receiver by mail/wechat/whatsapp etc.

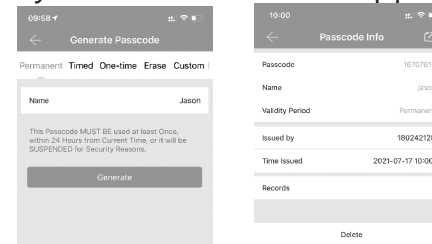

- Permanent passcode will not expire, but the administrator can delete them in the user list at any time.

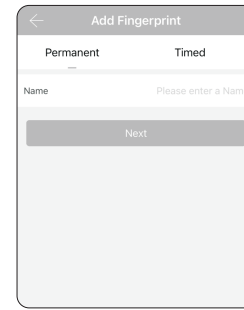
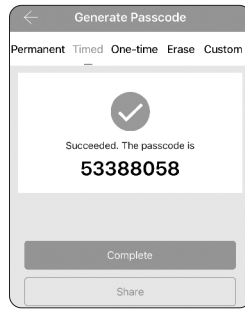
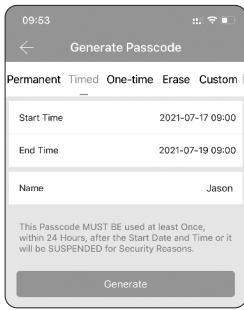

## 5. Issue IC Card

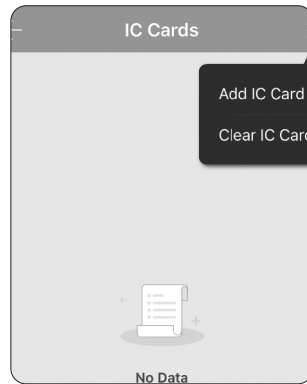
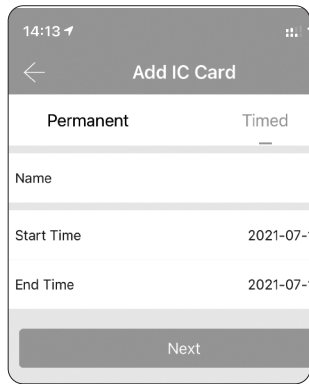

- There is tag card for this lock, which you can issue the IC card next the door lock, also you can clear the IC card upon your requirement.

## 6. Enroll User Fingerprint

You can enroll the fingerprint on the lock with permanent or timed period following the app instruction.

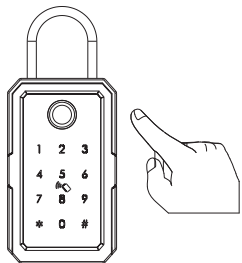

## 7. Unlock Record Query

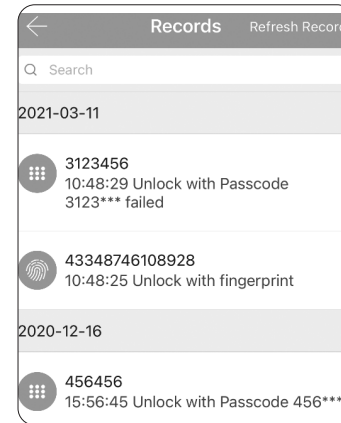

### ⚠ Attention

If one lock has been added by one phone, it can not be added by another new phone unless:

1. The previous administrator delete it from his APP next to the lock.
2. The reset button on the lock is long pressed for initialization (2 seconds).

- Deleting the passcode must be operated next to the lock. Enter the software interface and click the "≡" button to add the lock as the pop-up list suggest.
- Each time the ordinary user unlocks the door lock with the ekey sent by the administrator, one record will be generated automatically and send to the administrator's phone APP.

## 8. System Settings

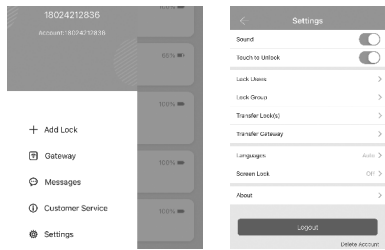

- Enter the interface and click the “≡” button, the options can be selected in the pop-up users.
- Notice: The passcode shall be used once within 24 hours after the start time, otherwise it will be invalid for security reason.

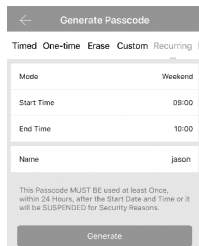

Notice: The recurring passcode is one week and can be used cyclically for one defined period of time. For example, if the time is valid when setting to 10:00-20:00 every weekend, the user can only open the door at the setting time every weekend and can not open the door at any other time. Also this passcode shall be used once within 24 hours after the start time, or it will be invalid.

## 9. Delete the Lock

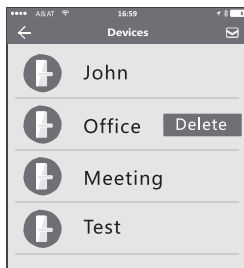

To delete the lock, find the name and left slide the delete button, you can delete the lock in the APP. Also you can long press the reset button on the rear side of front panel, so the other user can add this lock as new device.

## 6. Sales and Service Terms

- Please read the manual carefully before use!
- Limited 1-year Electronic Warranty Limited Lifetime Mechanical and Finish Warranty
- This K3 product comes with a 1-year Limited Warranty on Electronic Parts and a Limited lifetime. Mechanical and Finish Warranty against defects in materials and workmanship under normal use to the original residential user. Proof of purchase and ownership is required for the warranty to be in effect.
- Any error or question in our manual or sales term, please feel free to contact with us.
- For any wrong operation or installation to the user, we do not responsible for the duty.
- For the damage caused by anthropic factor or inevitable reason, we do not pay for the loss or maintain for free, please check our after sale service terms.
- Please do not take apart the lock if you are not technician, if necessary, please make the operations under the guide of technician.
- Notice: there maybe a little difference for product pictures with real product, please subject to our real products.